



warmcore[®]
FOLDING SLIDING DOOR SYSTEM

Installation guide | V1.1 | Nov 2014

This document is offered as guidance for WarmCore folding sliding door installations - for full survey and installation guidelines please refer to BS8213-4:2007

Pre-installation

DO NOT REMOVE THE EXISTING DOOR UNTIL YOU HAVE CHECKED THE FOLLOWING:

Make sure that the door which has been delivered is as specified when ordered.

Check all sizes are correct.

Check the product for any damage which may have occurred during transit (this must be reported within the specified Synseal Extrusions Ltd timescales and meet with the company Terms & Conditions of sale).

Removing the existing door

Remove (unscrew) the existing door set.

Score round the perimeter of the inside frame with a craft knife. This will help to minimise damage to the wall decoration and plaster when removing the outer frame.

Saw through the jambs and remove, sawing them diagonally in the centre and removing the two sections. Do not saw all the way through as it will cause damage to the internal reveals or structure. If this is likely to happen use a bearing block to protect the plaster and renderings, then lever the jambs away from the walls and complete the cuts.

Remove the top and bottom rails in the same way as removing the jambs.

Preparing the opening

If a door has been removed, clear any remaining screws or nails and any fillers or mastic.

Repair as required in accordance with BPF (British Plastics Federation) recommendations.

The opening should be complete before fitting the door. Check that a lintel or other load transferring structure is fitted above the doorway.

WarmCore doors are not load bearing therefore the above is obligatory.

Door alignment

The positioning of the new door within the existing brickwork opening is vital to the correct function of the new installation.

The following should be observed to maximise the effective use of the folding sliding door:

- Door outer frame set back as far as site will allow to reduce exposure to elements
- Bridge the wall only
- Cover the DPC
- Square / plumb*
- Frame not twisted*

*** If these criteria are not met you may encounter problems with fit and function, compression and hardware alignment.**

Pre-installation	p2	Glass packing	p5
Removing the existing door	p2	Glazing sequence	p6
Preparing the opening	p2	Glass packing locations for toe and heeling	p6
Door alignment	p2	Sill options	p8
Fitting outer frame WITH sashes	p3	Roller adjustment	p8
Fitting outer frame WITHOUT sashes	p3	Roller adjustment (double roller)	p8
Fixing positions	p4	Roller adjustment (single roller)	p9
Drilling	p4	Fitting the magnetic door catches	p9
Fixings	p4	Completing the installation	p9
Replace sashes back into outer frame	p5	Measuring and surveying guide	p9

Option 1: Fitting the outer frame **with** sashes in position

Sashes will need to be in the opened position and supported / balanced to take their weight.

Ensure that there is no movement of the sashes and that there is not a danger that the door may topple over due to the weight.

Installation of outer frame (with sashes still secured)

Offer the outer frame into the brickwork aperture. Pack into position and ensure that the sashes are in the fully opened position and supported to prevent them over-balancing. Once square and plumb, fix as per instructions. See pages 4-5 for fixings and positions.

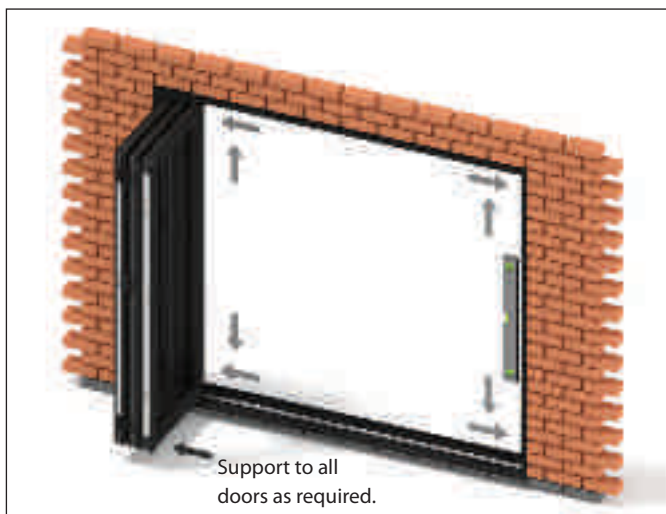

Silicone sealant should be applied to the brickwork opening across the entire width of the door to allow the sill to sit on this.

Temporarily secure the outer frame into the opening and pack where necessary.

Check that the head, sill and jambs are all plumb and level to ensure that the door set will function correctly.

Option 2: Fitting the outer frame **without** sashes in position

Remove sashes from outer frame

For the best results and to simplify fitting it is recommended that the sashes are removed from the outer frame prior to fixing into masonry.

Remove screws (as indicated by the red arrows below) to release door sash and remove.



Care must be taken to ensure that hinge packers located at the back of the hinge are not misplaced during this process.

It is advisable to ensure that all sashes are identified in order that they are re-fitted in the correct position.

Packers located in these positions (shown in orange for identification).



Installation of outer frame (with sashes removed)

With the door sashes removed from the outer frame offer into the brickwork aperture. Once square and plumb fix as per instructions. See pages 3-4 for fixings and positions.

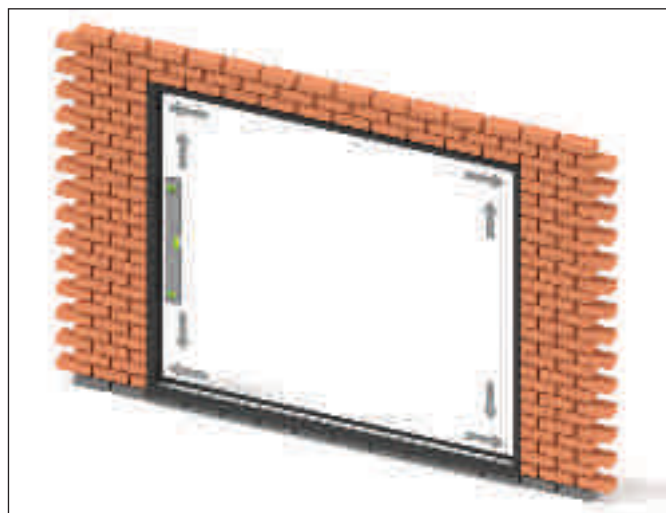

Ensure that the sashes once removed from the outer frame are carefully stored and that you have noted the exact location where each sash was removed.

Silicone sealant should be applied to the brickwork opening across the entire width of the door to allow the sill to sit on this.

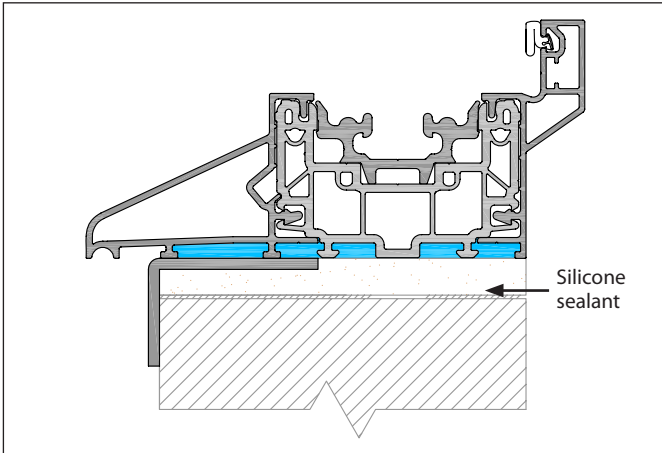

Temporarily secure the outer frame into the opening and pack where necessary.

Check that the head, sill and jambs are all plumb and level to ensure that the door set will function correctly.

NOTE: If sashes are removed please ensure that when they are replaced all screws achieve a positive fixing. If required replace screws with a suitable PVC-U repair screw.

Fixing positions

These positions are for guidelines only. Ensure fixings are into secure substrate.

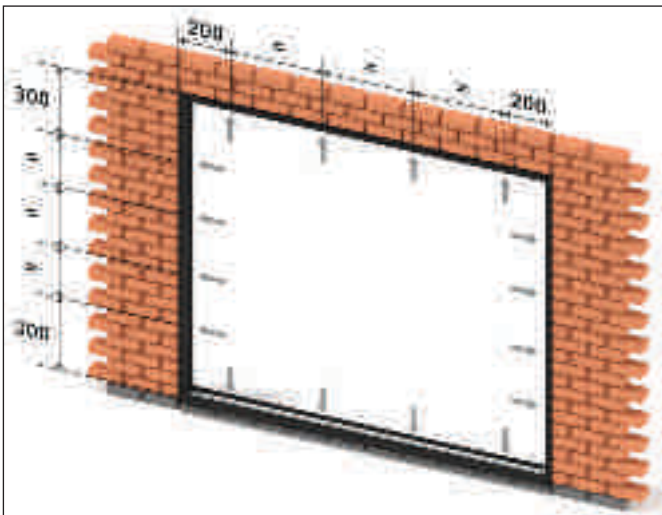

Recommended fixing positions are as follows:

Corner fixings: 150mm min and a max 250mm from external corner on **horizontal** section.

Intermediate fixings: Centres not exceeding 600mm.

Corner fixings: 250mm minimum and a max 350mm from external corner on **vertical** section.

Alternative fixing may be required due to lintel location / type when securing the head section.

Drilling

Determine from the options below whether you require to use the concealed option of fixing the outer frame or whether the fixings will be covered by screw cap covers.

Drill holes through frame in positions indicated (holes to suit manufacturer of frame fixing recommendations).

Option 1 - Concealed fixings

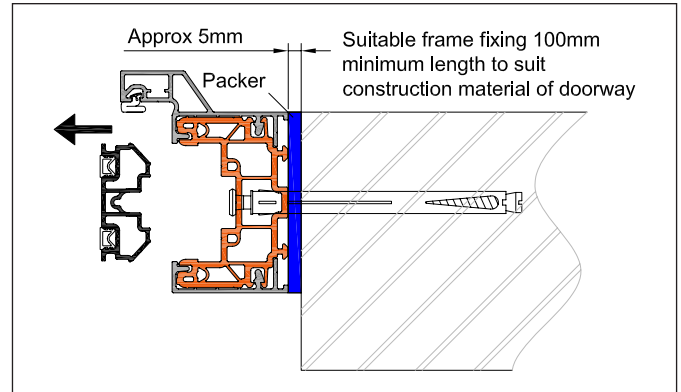

Option 2 - Cap covered fixings

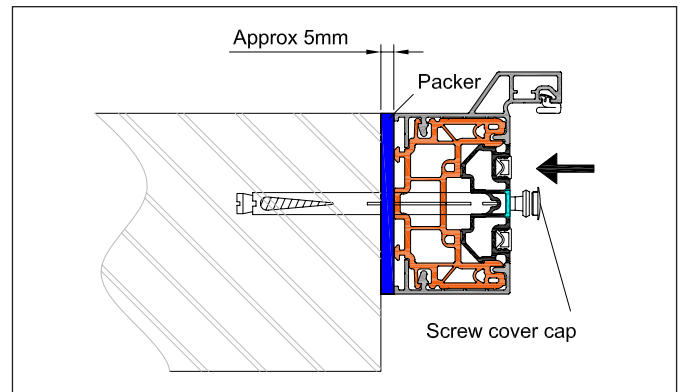

Fixings

The WarmCore outer frame should be secured into brickwork using industry standard plastic sheathed frame fixings. These should be minimum 100mm long and be fixed into masonry by minimum 50mm.

Tighten and secure all fixings ensuring that the frame is repeatedly checked for square / plumb as this proceeds.

Care should be taken not to over-tighten the frame fixings to avoid distortion of the frame.

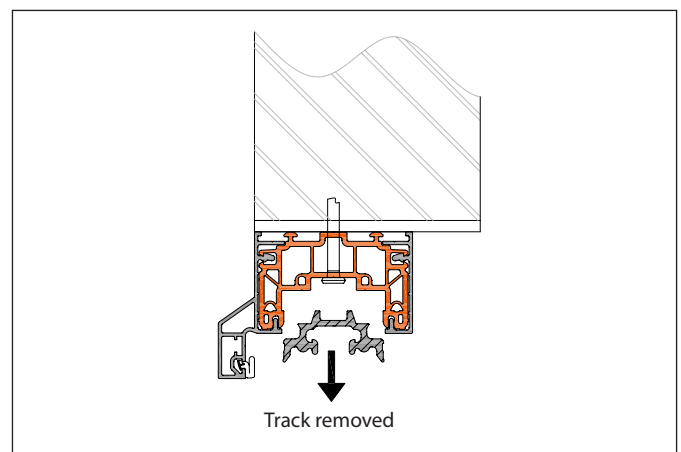

Glass packing

Sealant should be applied to fixings when fitted this way to prevent water ingress. Care must be taken to ensure that the fixing does not obstruct the door rollers.

Silicone sealant should be applied to the underside of the sill prior to installation of the frame.

Ensure that fixing used at the head of the door set is compatible with the lintel on site.

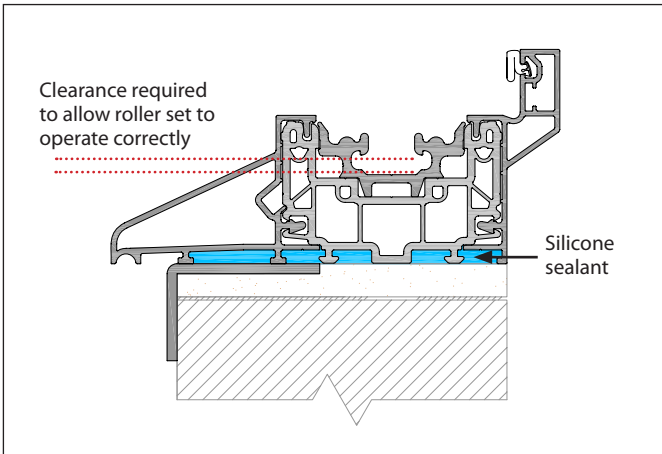

Clearance required to allow roller set to operate correctly

It is important not to over-tighten the fixings as this will distort the frame and prevent the doors operating correctly.

Please ensure that the fixing will not interfere with the smooth passage of the sliding folding door rollers.

Replace sashes back into outer frame

Take care that the replaced sashes are put into exactly the same position that they were removed from, and ensure that all packers are located on the hinge correctly.

Check page 6 to confirm correct location.

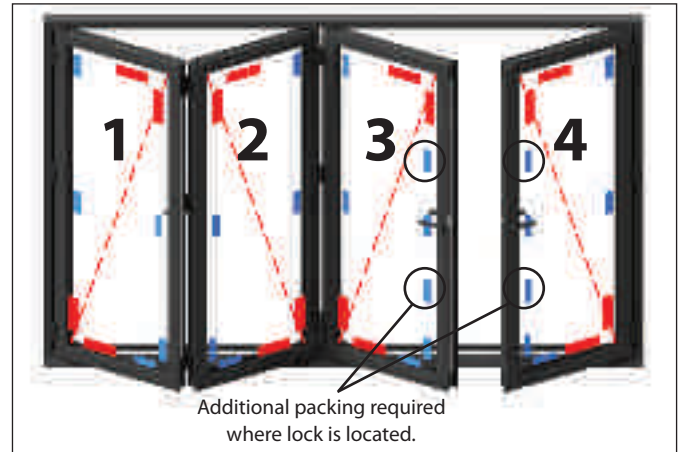
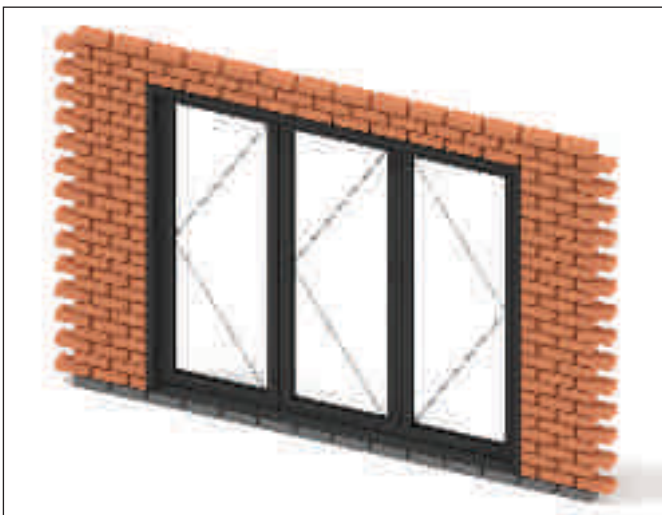

Indicates pressure point (Load-bearing packers)

For packing doors up (e.g. toe and heeling). Important for ensuring correct operation of door.

Indicates packing point

For packing at hinge and lock points.

Glass packing / toe and heeling for 4-3-1 door configuration. See pages 6 to 7 for recommendations on all style options. Glass should be toe and heeled to ensure correct operation and additional packing used at hinge and lock points.

Ensure a gap of approximately 25mm is left from corner of frame when placing packers so that they do not interfere with beading.

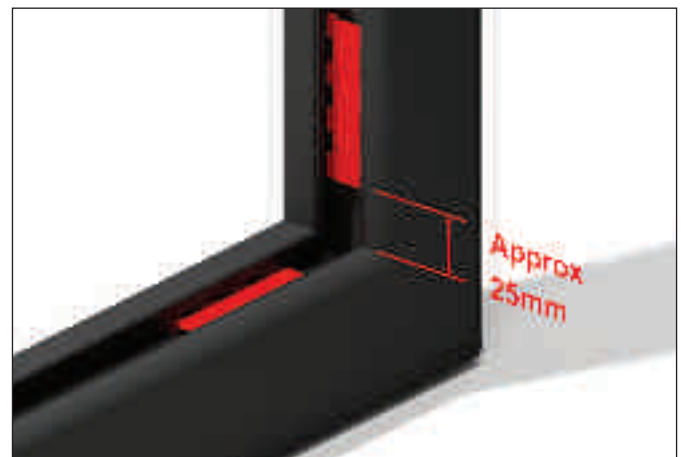

Check that sashes are level by taking measurements from the top frame section as shown. Repeat for all sashes.



Glazing sequence

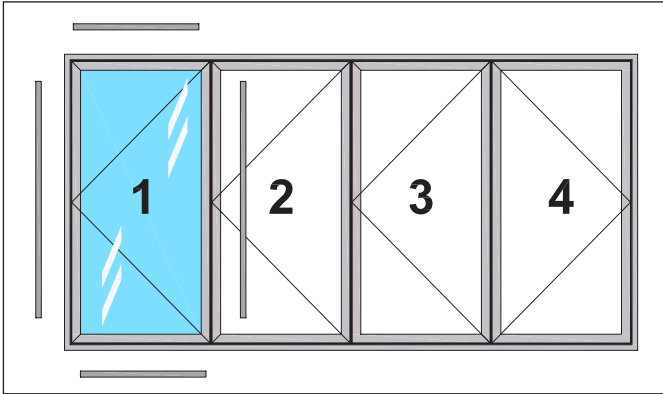

Remove beads from one door sash at a time, taking note of the location they are removed from to ensure that they are replaced into their original positions.

Repeat process until all sashes are glazed.

Ensure that all sashes are 'toe and heeled' as per guidelines on pages 6 and 7.

28mm Double Glazing

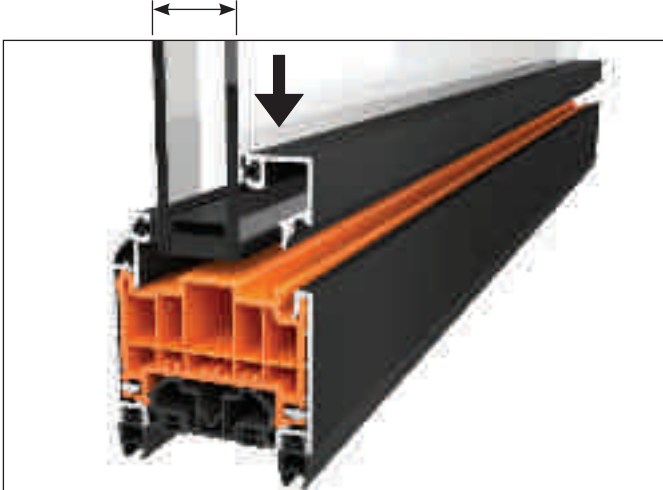

44mm Triple Glazing



NOTE: A rubber mallet is recommended for glazing to reduce risk of damaging beads.

Packing locations for toe and heeling

Scheme 2 2 0

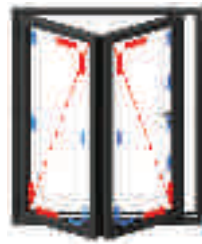

Scheme 3 3 0

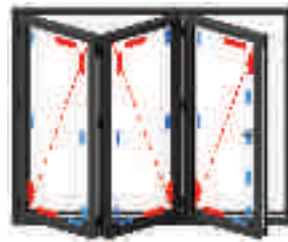

Scheme 3 2 1

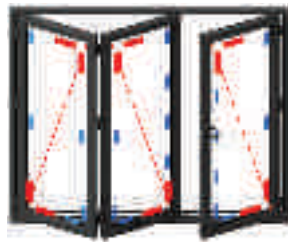

Scheme 4 2 2

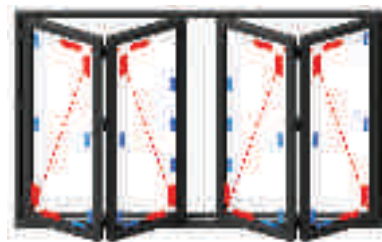

Scheme 4 4 0

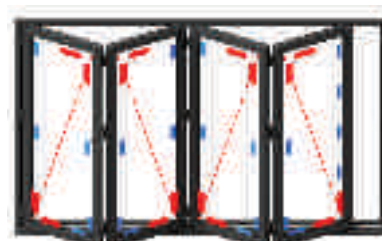

Scheme 4 3 1

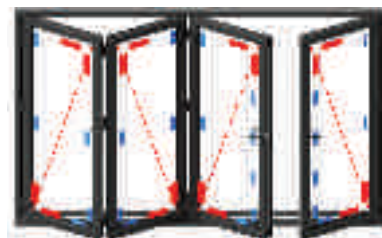

Scheme 5 5 0

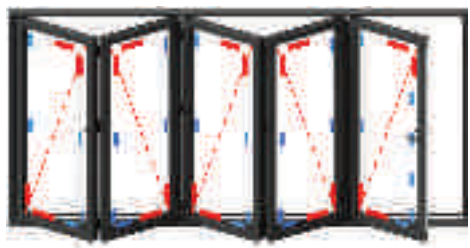

 Indicates pressure point
(Load-bearing packers)

 Indicates packing point

NOTE: All schemes are available as opposite hand to version shown.

Scheme 5 4 1

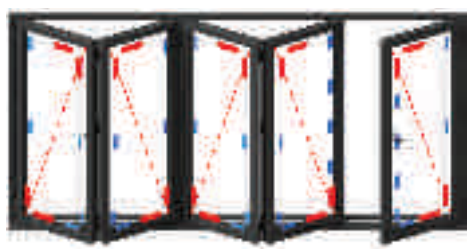

Scheme 5 3 2

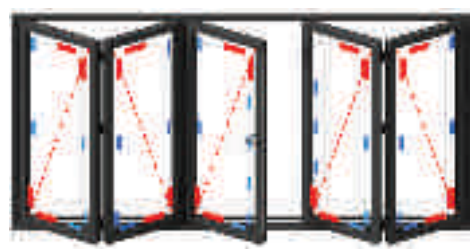

Scheme 6 6 0

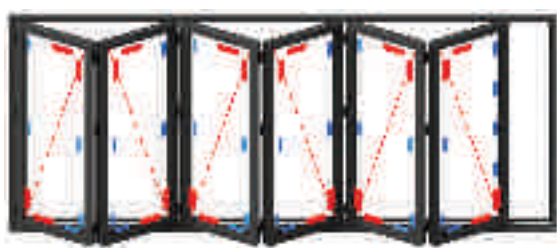

Scheme 6 5 1

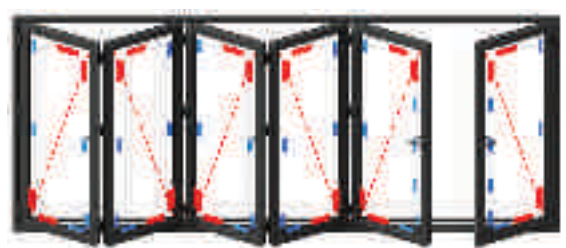

Scheme 6 4 2

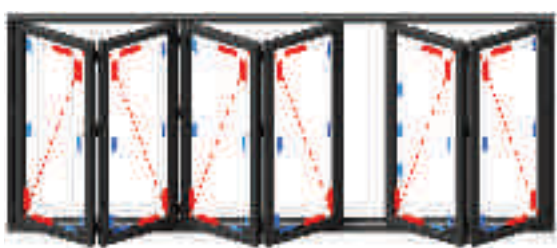

Scheme 6 3 3

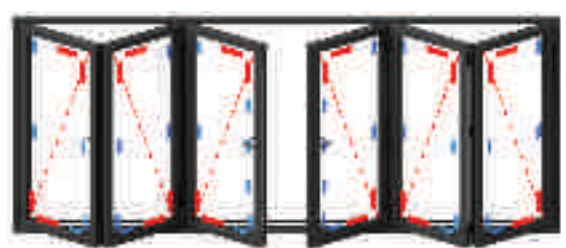

Scheme 7 7 0

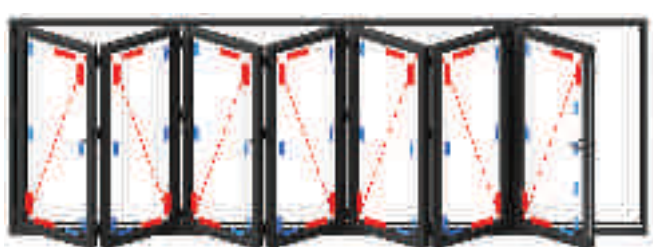

Scheme 7 6 1

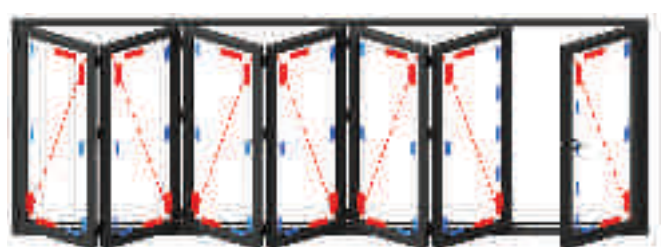

Scheme 7 5 2

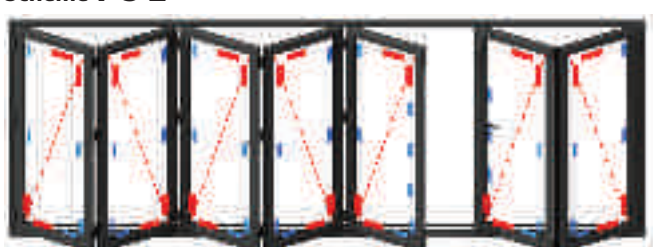

Scheme 7 4 3



Sill options

Integrated sill option

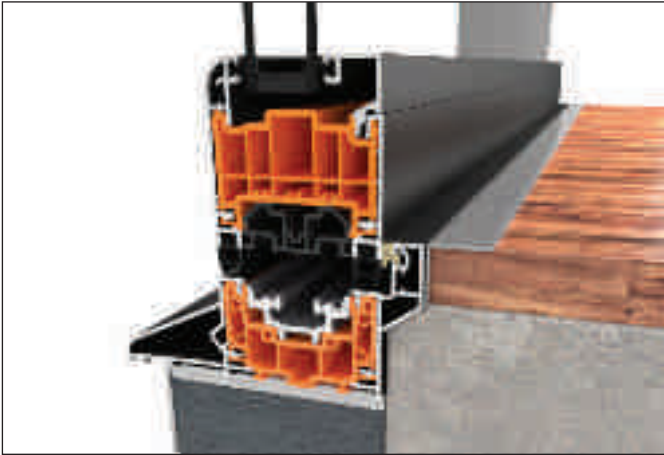

Low threshold option



150mm sill option

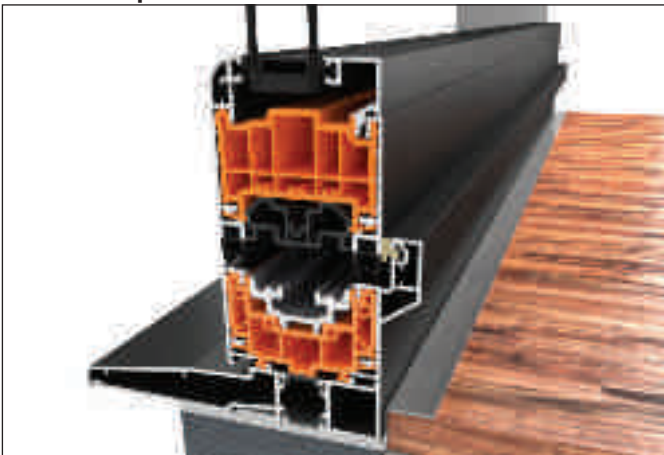

Roller adjustment

Cap and keyway must be removed to access screw adjustment. Remove screw and cap (A) then use an M5 x 40 bolt (B) to remove keyway (C).

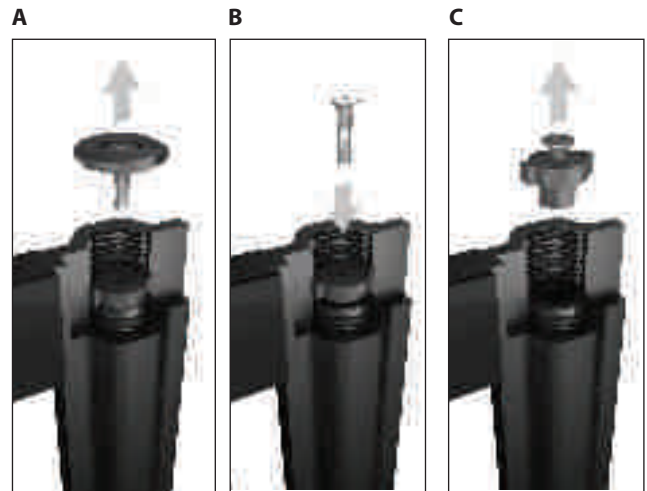

Roller adjustment (double roller)

Release grub screw at lower end of roller as shown below with a 2.5mm Allen key prior to rotating the 8mm Allen screw for height adjustment.



Please ensure that the equivalent grub screw on the top roller set is also released to allow adjustment.



Once cap and keyway are removed (see above) use an 8mm Allen Key for +/- 3mm adjustment to rollers.

Rotate **clockwise** for **upward** adjustment.

Rotate **anti-clockwise** for **downward** adjustment.

Roller adjustment (single roller)

Release grub screw at lower end of roller as shown below with a 2.5mm Allen key prior to rotating the 8mm Allen screw for height adjustment.

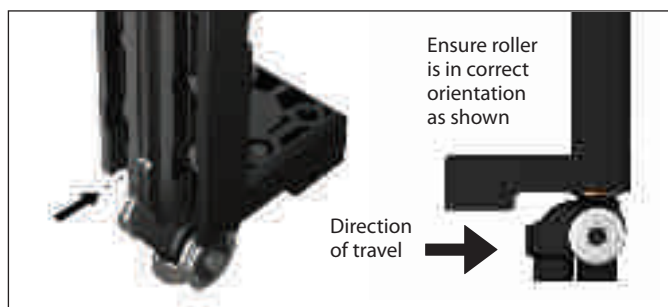

Remove cap and keyway (as shown on p8) to access Allen screw adjustment. Use 8mm Allen key for +/- 3mm adjustment to rollers.

Rotate **clockwise** for **upward** adjustment

Rotate **anti-clockwise** for **downward** adjustment



Fitting the magnetic door catches

Recommended positions for door catch are shown below in red.

This is intended as a guideline only and is not definitive.



NOTE: Door catches same dimensions from top of door.

Completing the installation

Silicone sealant must be applied to the entire perimeter of the outer frame to ensure that a weather-tight seal is achieved.

Ensure that the door track is clean and free from debris which may impede the correct operation of the door set. The door track must be unobstructed to achieve optimum motion of door roller sets.

A fine spray of silicone will assist with the smooth operation of the doors.

Measuring and surveying guide

The following is intended as a brief guide to determining the height and width of door required. The door is to be viewed from the outside.

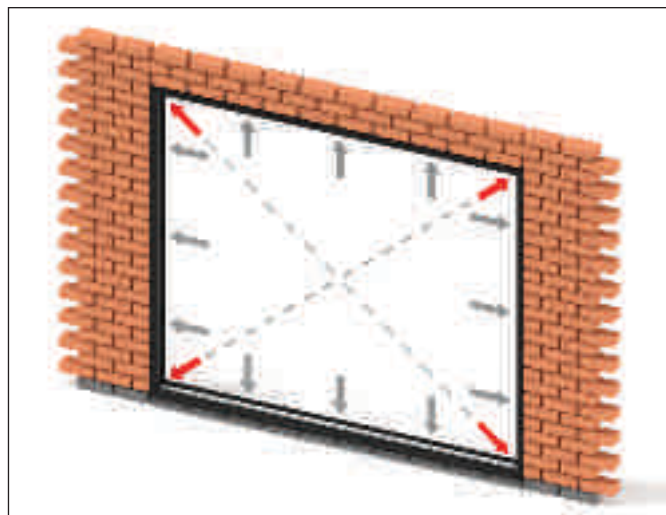

Step 1

Measure the width of the aperture in at least three different places as indicated above by the red arrows.

Take the smallest of these and deduct 10mm to obtain the width of the door set.

Step 2

To determine the height of the door first find where the finished floor level will be including any floor covering.

Now determine where the sill (or threshold) will sit. Measure the height of the door from the underside of the threshold or sill. Take a minimum of three measurements as indicated above, use the smallest of these dimensions and deduct 10mm to give the overall height of the door set including sill (or threshold).

Step 3

Check the aperture is square by comparing the diagonal cross corner dimensions.

Step 4

Please ensure that the following points are considered when surveying for a new WarmCore folding sliding door:

- Floor levels in relation to the height of the track and frame.
- Evaluate the position of the plaster line and the need for minimal disturbance to interior decor.
- The head of the door will normally be fitted to a lintel, please ensure that the lintel manufacturer's guidelines are adhered to.
- Make sure there is plenty of clearance for the doors to open in the direction that they will travel.

Notes

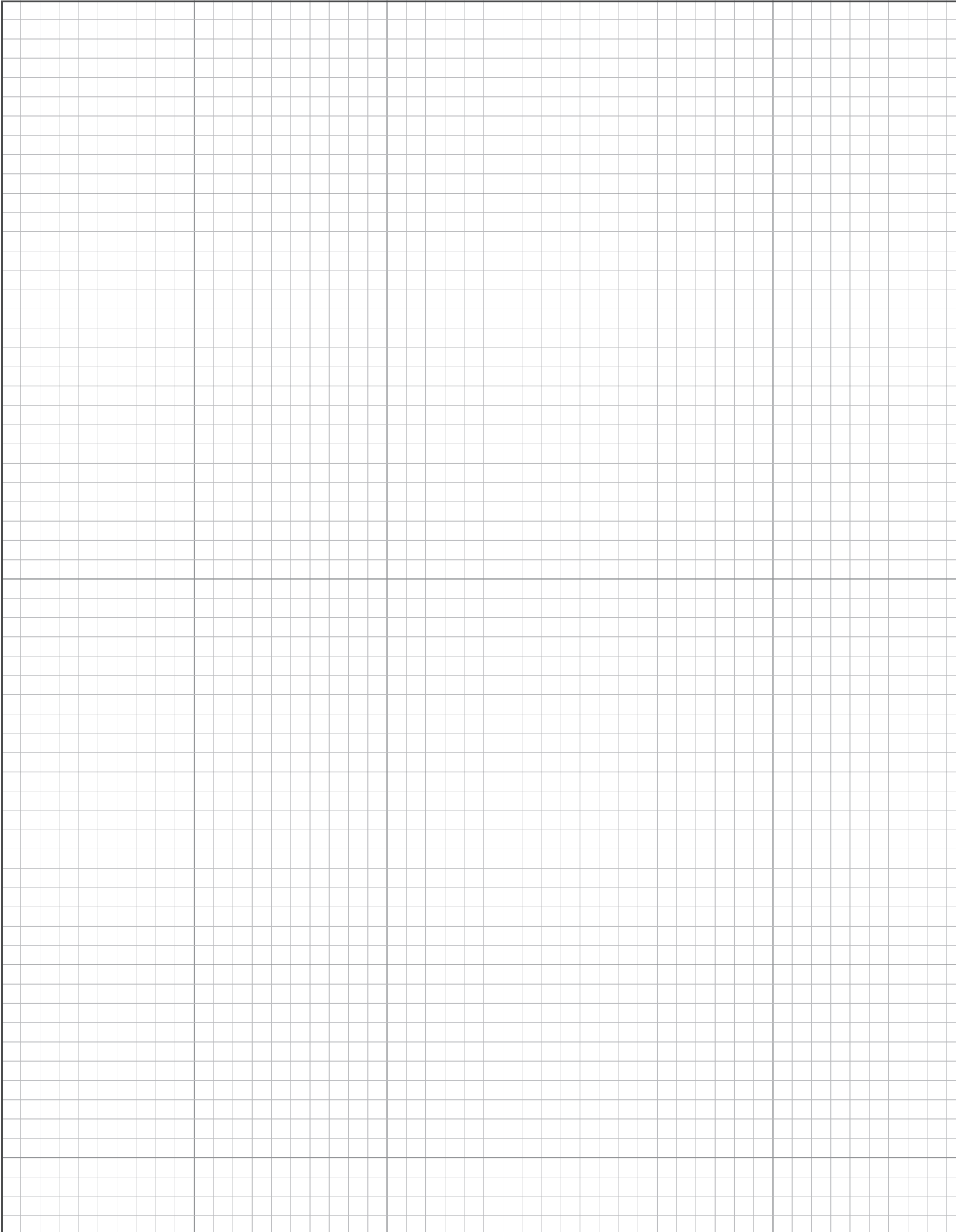

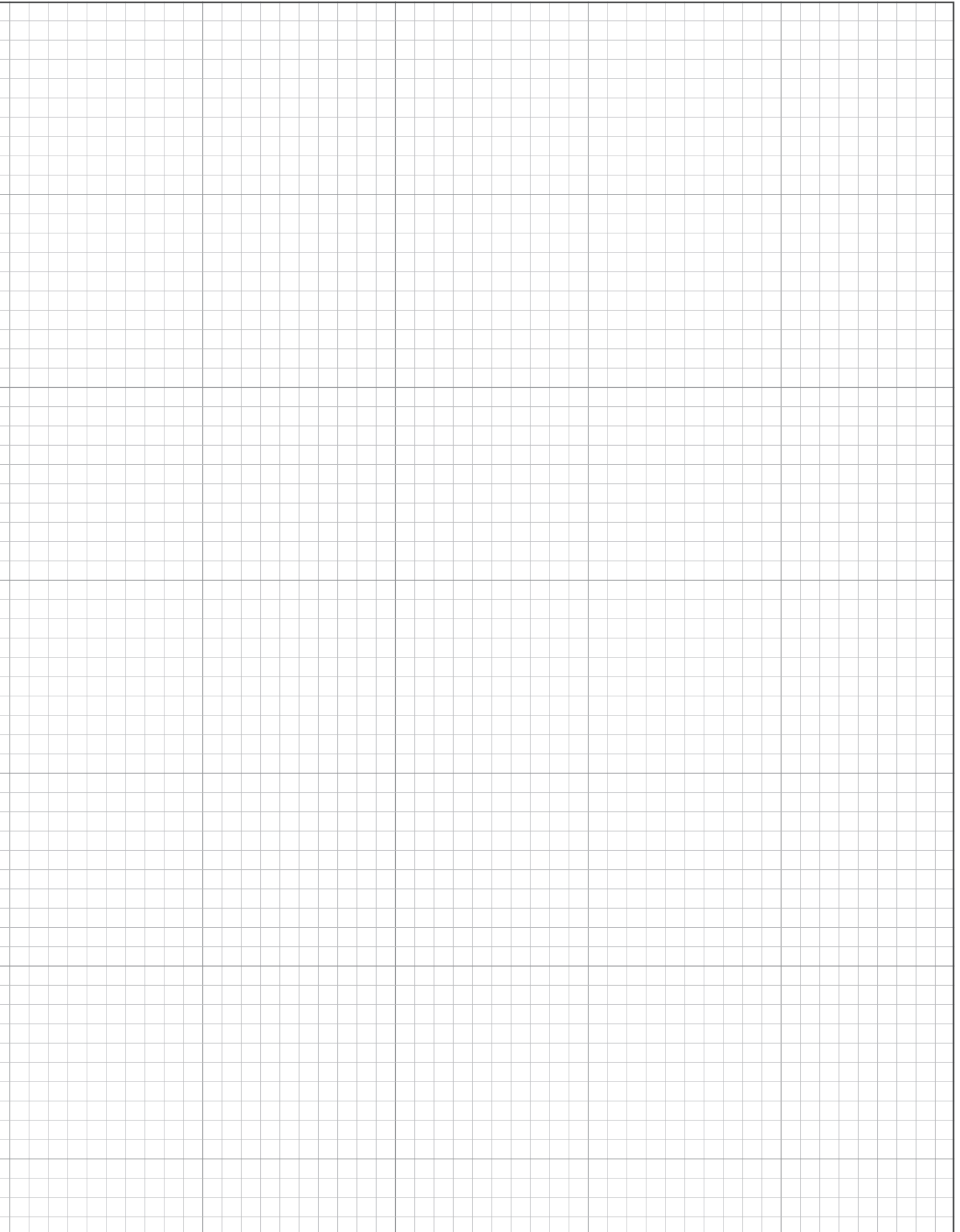



Synseal

Common Road | Huthwaite
Nottinghamshire | NG17 6AD

Tel 01623 443200

Fax 01623 550243

www.synseal.com

warmcore[®]
FOLDING SLIDING DOOR SYSTEM

WARMCORE.CO.UK